

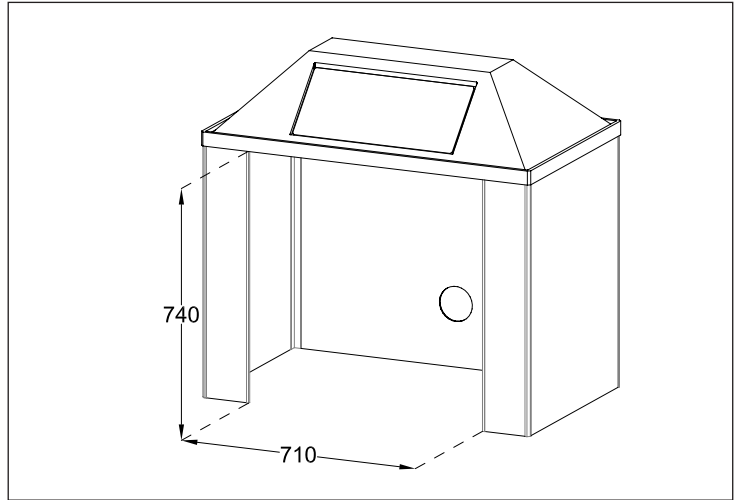

25-106075

The measurements of the cabinet have been taken at a volume velocity of 473 and 945 m³/h respectively.

Opening:
Geometric area: 0.533 m²
Effective area: 0.501 m²



Coherence between volume velocity and wind velocity

The below table shows the coherence between the volume velocity and the wind velocity of the effective opening area. The effective area is used instead of the geometric area because turbulence along the edges of the opening slows down the air velocity. This results in an area along the edge where the suction efficiency is too low.

$$q_v = A \cdot v \cdot 3600 \text{ s/h}$$

q_v = volume velocity [m³/h]
 A = the effective area [m²]
 v = air velocity [m/s]

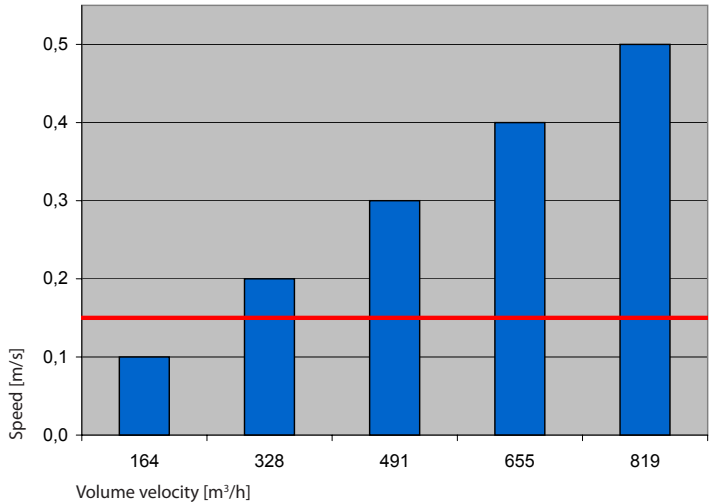

■ Volume velocity — Draught limit